

Overview - frames

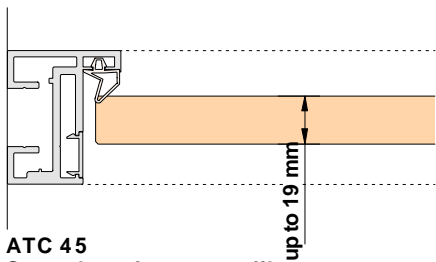

ATC 45
 Stop-door frame profile
 wall fixed

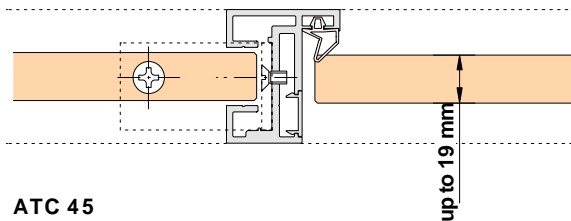

ATC 45
 Stop-door frame profile
 freestanding frames

Overview - frame profiles

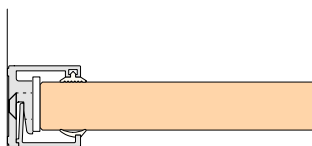

MRC 29
 Frame profile for wood-fillings
 and plastic-boards up to 19 mm

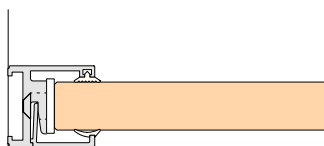

MRC 35
 Frame profile for wood-fillings
 and plastic-boards up to 19 mm

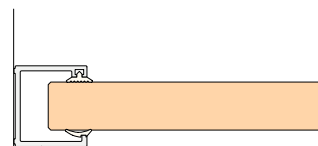

Profile No. 594
 Frame profile for wood-fillings
 and plastic-boards up to 19 mm

Profile No. 594
 Filling profile

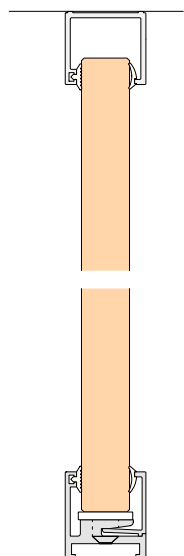

MRC 35
 Frame profile

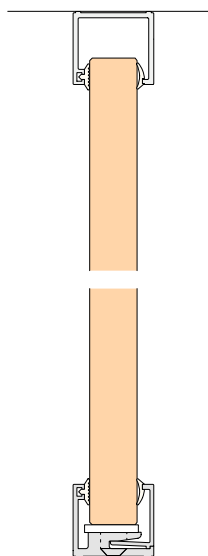

MRC 29
 Frame profile

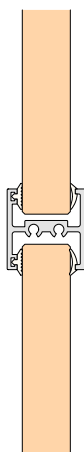

Muntin profile
 No. 596 for MR 28

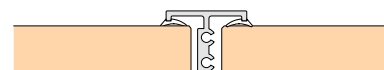

Profile No. 596 - 180°

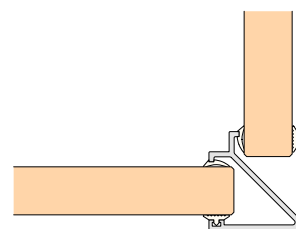

Profile No. 587 - 90°

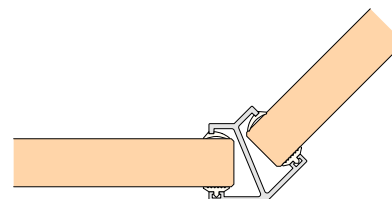

Profile No. 586 - 135°

Technical information

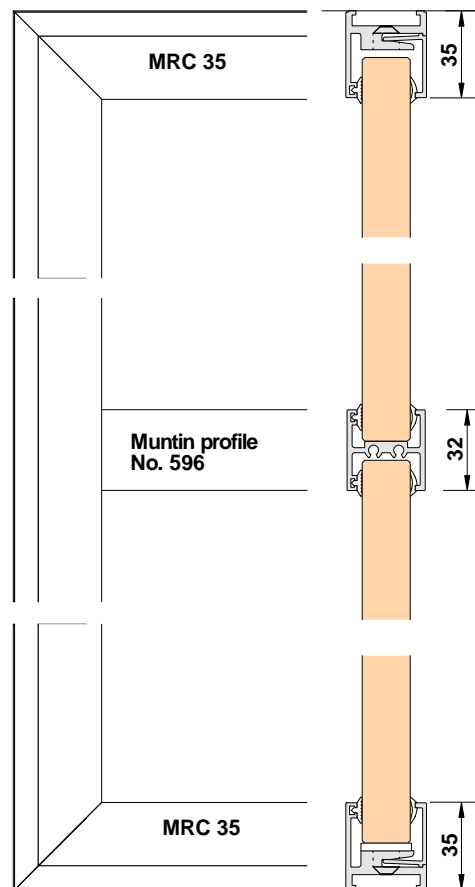
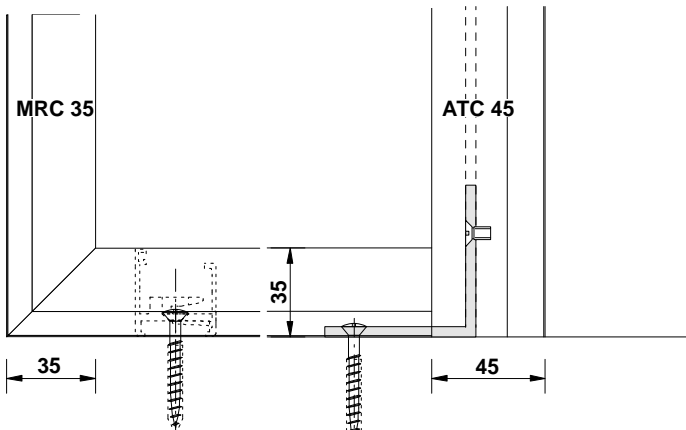
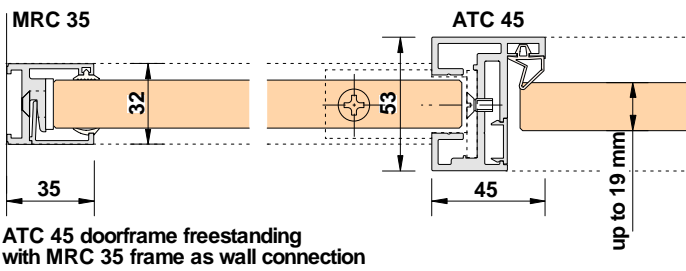
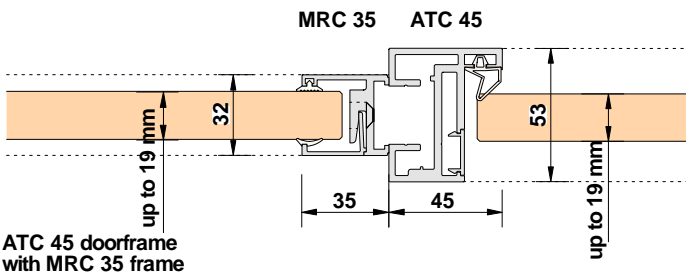
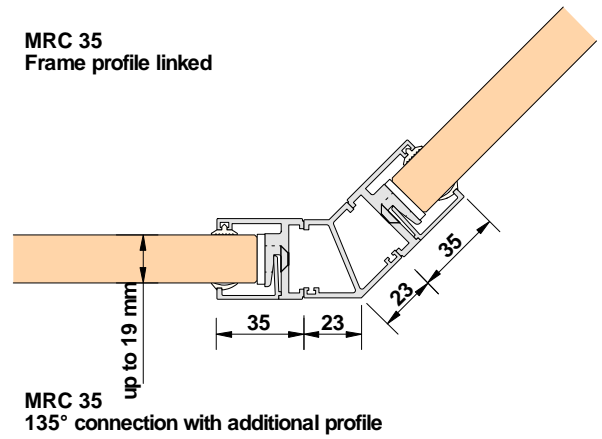
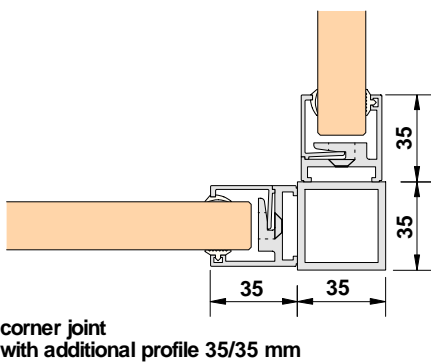
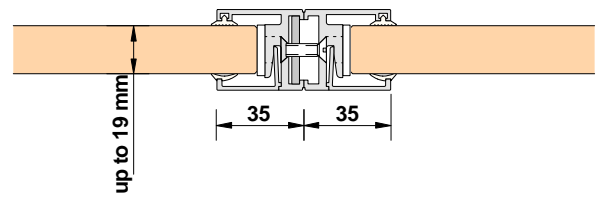
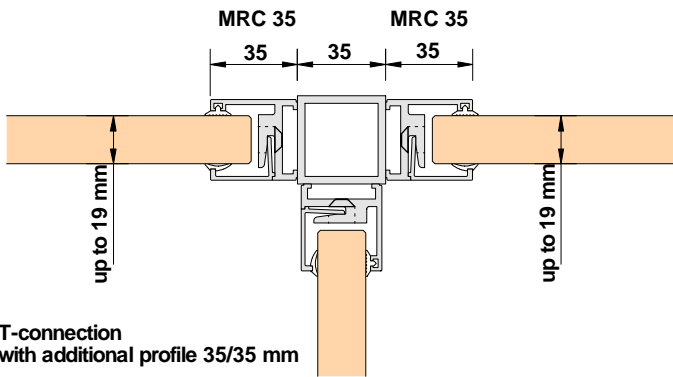

Types overview MRC-35 frames

In combination with MRC-29 and ATC-45 frames

MR 28 frames - types overview

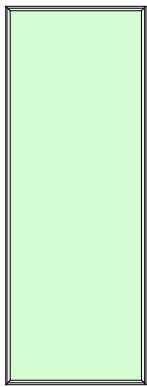

Type 640

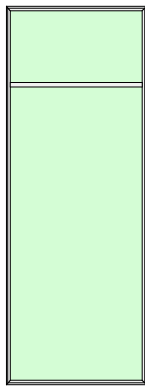

Type 640 / S

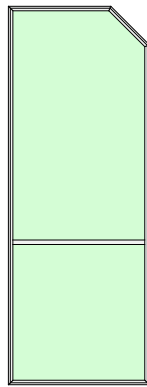

Type 640 / S / TS

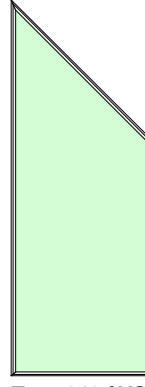

Type 640 / VS

S = muntin profile
TS = partly angular
VS = complete angular

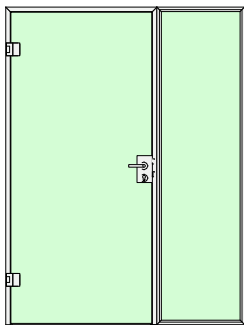

ATC 45 doorframe with door and fixed frame MRC 35

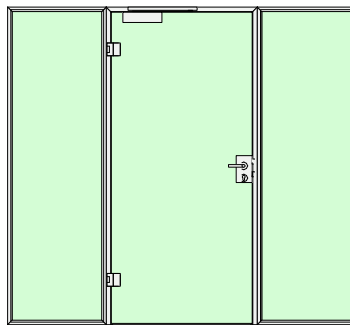

ATC 45 doorframe with door and 2 fixed frames MRC 35

Variation possibilities with ATC 45 frames

With the pictured combinations of doorframes and frame constructions we want to show you the multiplicity of our systems.

For more technical information our team is available.

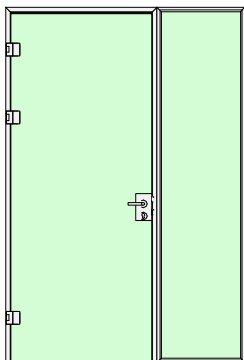

ATC 45 doorframe with glasdoor and fixed frame MRC 35

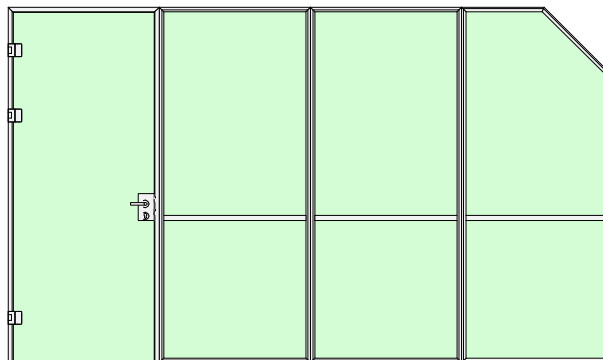

ATC 45 doorframe with glasdoor and frame combinations MRC 35

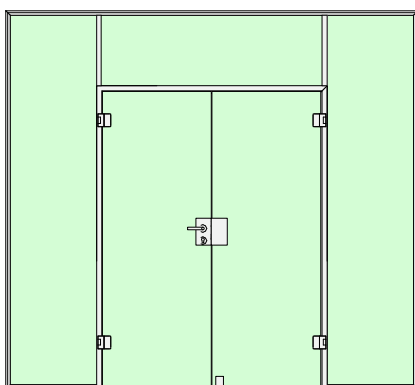

ATC 45 doorframe with 2 doors and frame combinations MRC 35

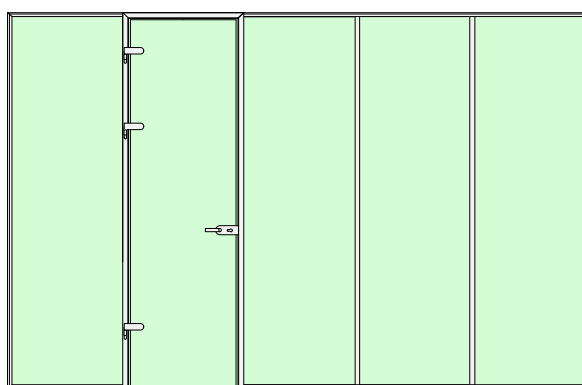

ATC 45 doorframe with door and glas partition MRC 35

Types overview MRC-35 frames

In combination with MRC-29 and ATC-45 frames

Deubl Alpha ATC 45 stop-doorframes

Freestanding stop-doorframes for Dorma Junior- and Studio-Programm

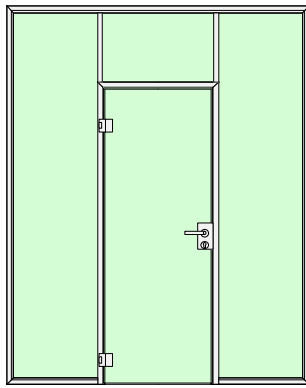

Type 650 - 35

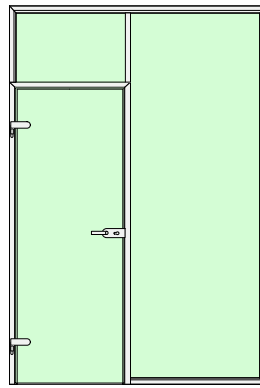

Type 670 - 35 left

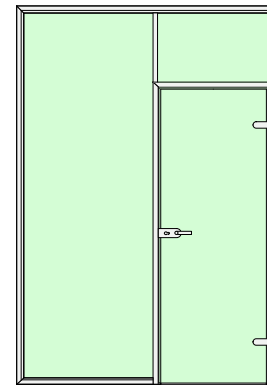

Type 670 - 35 right

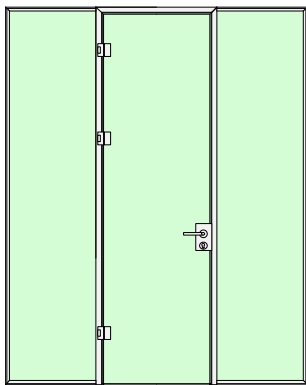

Type 660 - 35

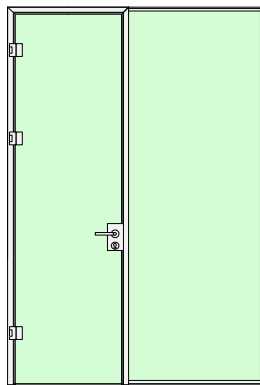

Type 680 - 35 left

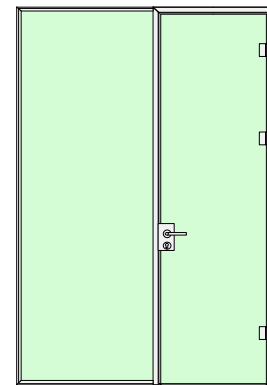

Type 680 - 35 right

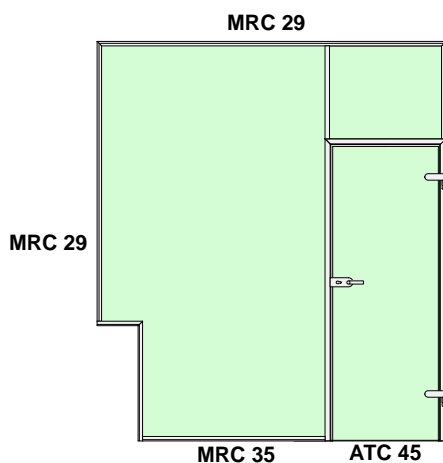

Type 570 , e.g. for balustrade facings

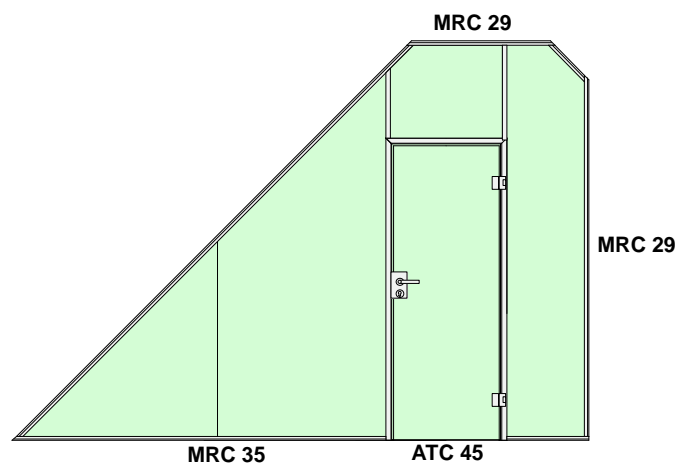

Type 550 , e.g. for roof pitches with MRC 29 and MRC 35 profiles

Variation possibilities with ATC 45 frames

With the pictured combinations of doorframes and frame constructions we want to show you the multiplicity of our systems. For more technical information our team is available.

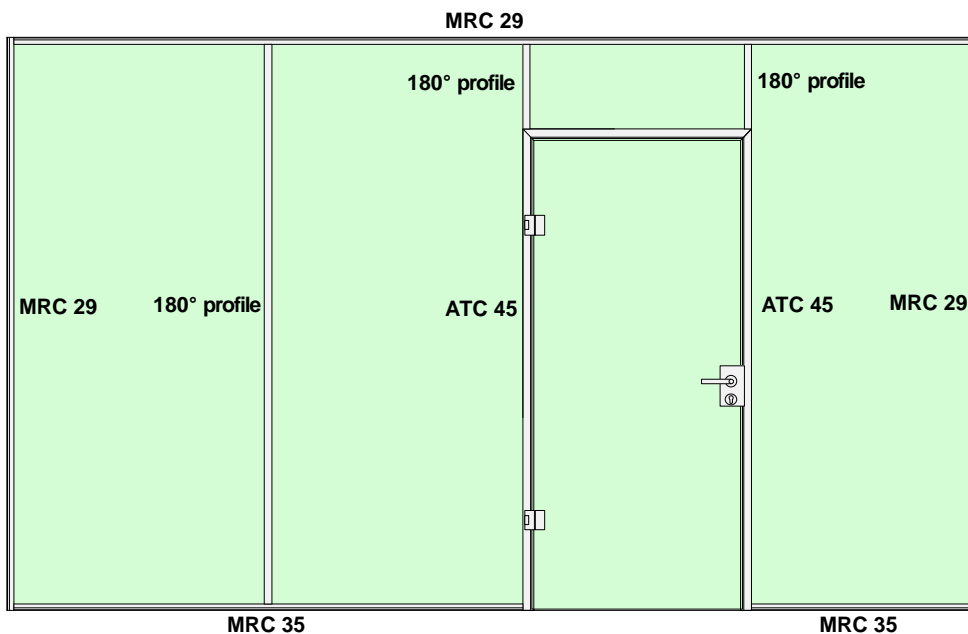

Type 650 - 29
freestanding frame with ceiling connection

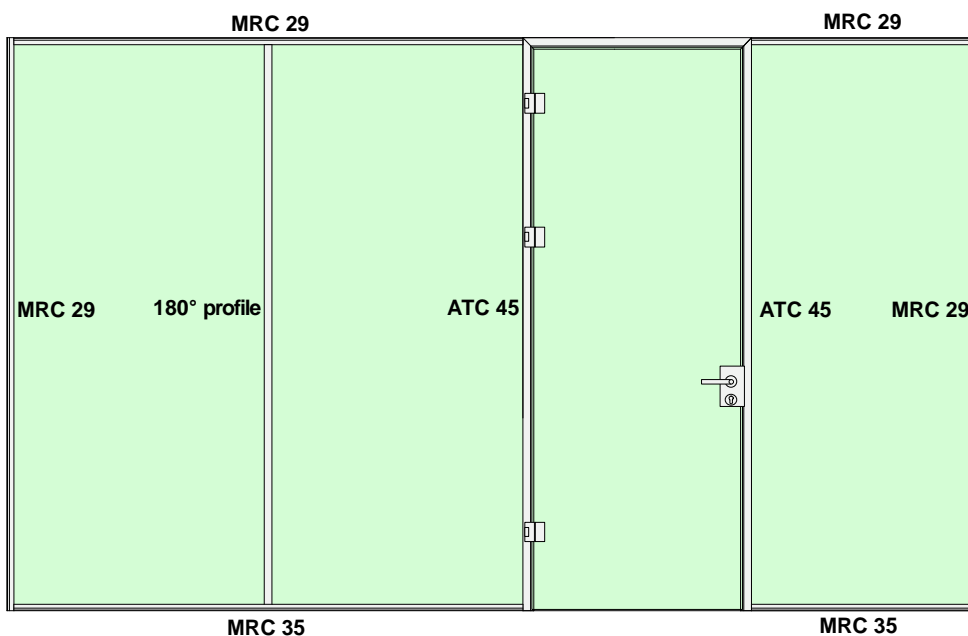

Type 660 - 29
freestanding frame with ceiling connection

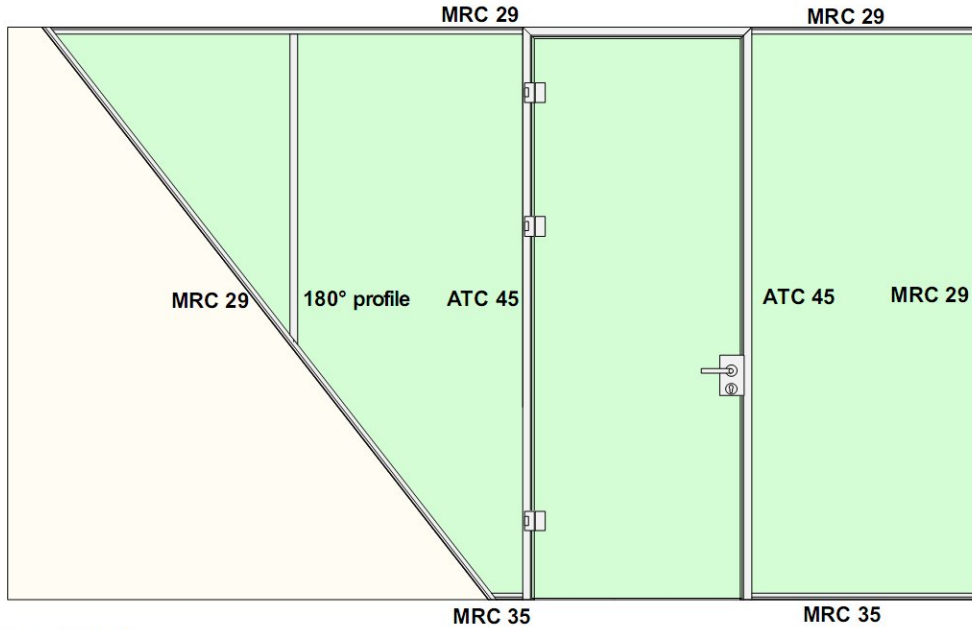

Type 660 - 29
freestanding frame with ceiling connection

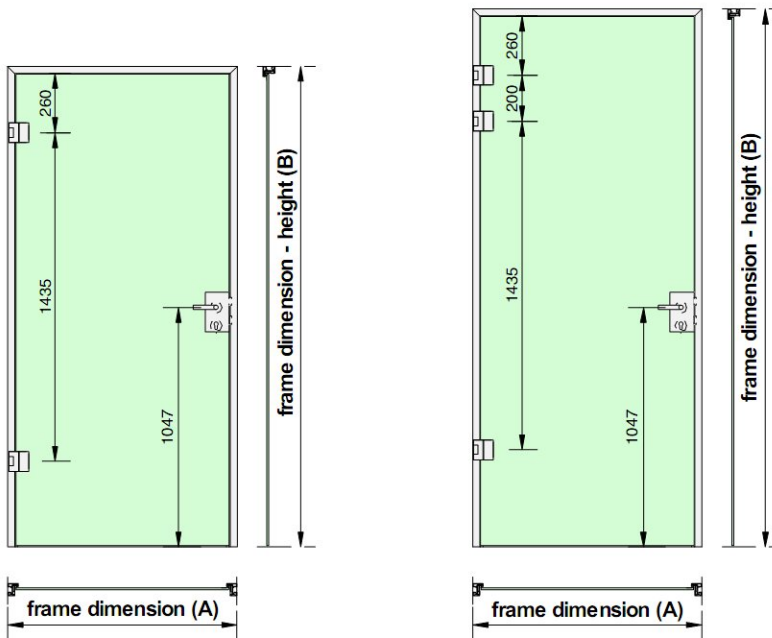

ATC 45 frame with 2 bands,
lock casing + handle set

ATC 45 frame with 3 bands,
lock casing + handle set